

A very small intro to Diversification Models

Rosana Zenil-Ferguson, Will Freyman, and Jordan Koch

University of Minnesota

Botany 2018

Diversification in Macroevolution

Key questions: What creates species? Why do species go extinct?

Diversification in Macroevolution

Key questions: What creates species? Why do species go extinct?

- ▶ Is this trait a key innovation?
- ▶ Does species-level selection act on this trait?

Diversification in Macroevolution

Key questions: What creates species? Why do species go extinct?

- ▶ Is this trait a key innovation?
- ▶ Does species-level selection act on this trait?

Questions of trait evolution are intrinsically linked with diversification

The Birth-Death model

- ▶ Continuous Time Markov Chain. Create a new lineage with rate λ and a lineage goes extinct with rate μ

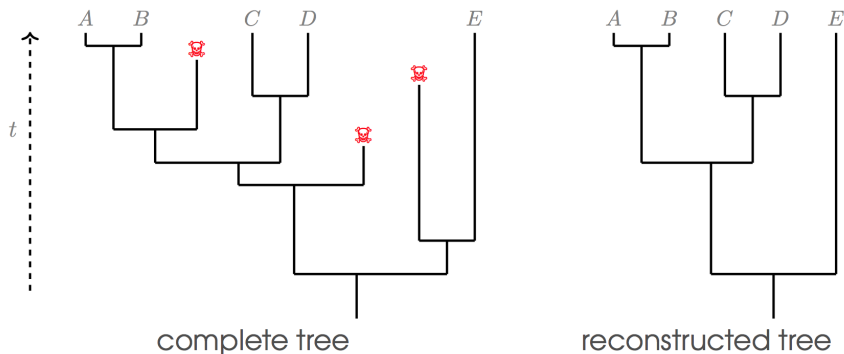

State dependent diversification models

- ▶ State diversification models are birth and death models + trait evolution models

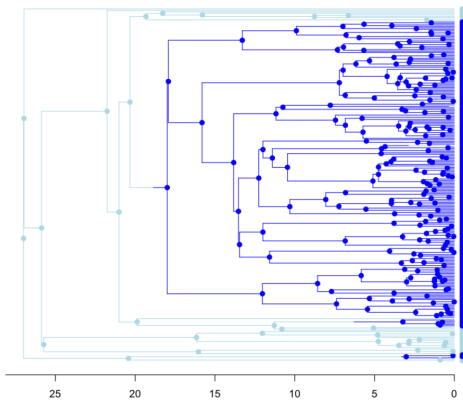
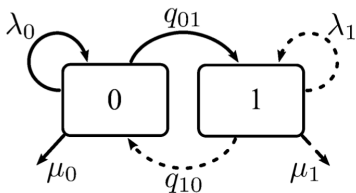

Mathematics of BiSSE are more complex

Since the number of lineages that speciate or go extinct are infinite, the Q -matrix that BiSSE defines is infinite!

$$Q = \begin{pmatrix} - & \lambda_0 & 0 & 0 & \infty \\ \mu_0 & - & \lambda_0 & 0 & \infty \\ 0 & \mu_0 & - & \lambda_0 & \infty \\ \vdots & \ddots & \ddots & \ddots & \infty \end{pmatrix}$$

And we need the exponential?

Calculating the probabilities of a BiSSE (and any SSE)

Remember that the Q is the derivative of the probabilities so that defines a series of equations

Within branches

a) No state change,
No speciation

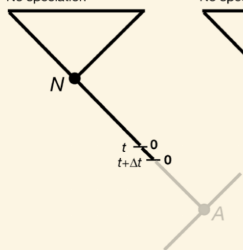

b) State change,
No speciation

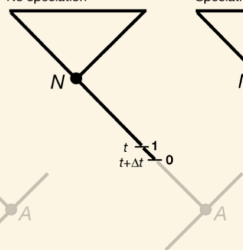

c) No state change,
Speciation & Extinction

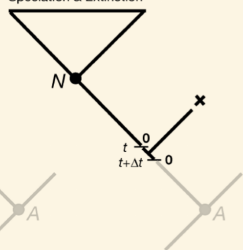

d) No state change,
Speciation & Extinction

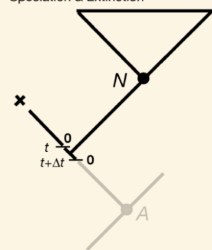

$$\frac{dD_{N0}(t)}{dt} = -(\lambda_0 + \mu_0 + q_{01}) D_{N0}(t) + q_{01} D_{N1}(t) + 2\lambda_0 D_{N0}(t) E_0(t)$$
$$\frac{dD_{N1}(t)}{dt} = -(\lambda_1 + \mu_1 + q_{10}) D_{N1}(t) + q_{10} D_{N0}(t) + 2\lambda_1 D_{N1}(t) E_1(t)$$

Diversification Models in RevBayes

We are going to connect two models as building blocks
The discrete trait model with a birth-death model

Potential pitfalls of state dependent diversification models

- ▶ State dependent diversification models only consider one (or very few) scenarios of diversification (Beaulieu and O'Meara, 2016)

Potential pitfalls of state dependent diversification models

- ▶ State dependent diversification models only consider one (or very few) scenarios of diversification (Beaulieu and O'Meara, 2016)
- ▶ Diversification rates are in most of the cases heterogeneous by default (Beaulieu and O'Meara, 2016)

Potential pitfalls of state dependent diversification models

- ▶ State dependent diversification models only consider one (or very few) scenarios of diversification (Beaulieu and O'Meara, 2016)
- ▶ Diversification rates are in most of the cases heterogeneous by default (Beaulieu and O'Meara, 2016)
- ▶ Spurious significant differences in diversification can be the result of a single shift of trait (Maddison and Fitzjohn, 2015)